

# PANO 5.25"

## WOODWORKS®

LINEAR SOLID & VENEERED WOOD PANELS



**5 YEAR**  
limited  
led warranty



### PERFORMANCE

- Coordinates with Woodworks® Linear & Veneered ceiling panel
- Up to 124lm/W
- High performance opal cover
- Remote mountable LED driver
- Damp rated

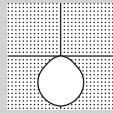

### WoodWorks® Grille Ceiling Integration

#### Linear Solid Wood Panel

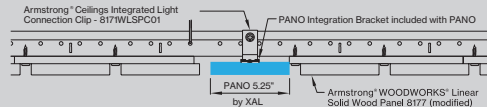

#### Linear Solid Wood Panel

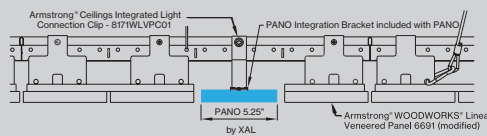

### REMOTE MOUNTING

Quick and easy electrical connection

#### REMOTE MOUNTING



[link to page](#)

### ARMSTRONG CEILING TYPES

WARM, AESTHETIC ROOMS

WT5 - WOODWORKS®  
GRILLE TEGULAR 1<sup>5</sup>/<sub>16</sub>"



WT5 - WOODWORKS®  
GRILLE TEGULAR-VERTICAL SLATS



WLS - WOODWORKS®  
GRILLE SOLID WOOD PANELS



WLV - WOODWORKS® GRILLE  
VENEERED PANELS

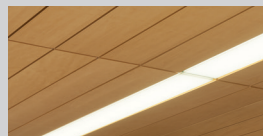

### Catalog Number Example

PANO5-WLS-WH-PS-OP-27K-C80-UNV-010V-0550LF-ST-08FT

#### A RANGE

PANO 5.25" PANO5

#### H VOLTAGE

120V / 277V UNV

#### B CEILING TYPE

WoodWorks® linear WLS  
solid wood panels  
WoodWorks® linear WLV  
veneered panels

please contact your Armstrong® ceilings  
rep for the Integrated Light Connection  
Clip for the specified ceiling type

#### I DIMMING

0-10V 1% 010V  
Lutron EcoSystem LES1  
Quantum, Vive, GRAFIK Eye,  
HomeWorks

Power over ethernet POEC  
consult customer service for compatibility  
Custom dimming XXXX  
consult customer service for compatibility

#### C COLOR

White WH  
Black BL

#### J OUTPUT LM/FT

550lm/ft 100% ↓ 0550LF  
775lm/ft 100% ↓ 0775LF  
1000lm/ft 100% ↓ 1000LF

#### D POWER FEED LENGTH

4' standard integrated PS  
10' medium remote option PM  
30' long remote option PL

power feed distance denotes secondary  
wiring from detachable driver box  
to fixture; driver box comes with a 6ft  
conduit for primary wiring

#### K CIRCUIT / EM

Single circuit \*

\* leave blank

#### L SHAPE / PATTERN

Linear / straight ST

#### E LENS

HP opal cover OP

#### M DIMENSIONS IN FT

4' fixture 04FT  
6' fixture 06FT  
8' fixture 08FT

fixture replaces full length of ceiling  
panel; please see table on next page  
and fixture length dimensions

#### F CCT

2700K 27K  
3000K 30K  
3500K 35K  
4000K 40K  
Custom CCT XXX

#### G CRI

CRI > 80 C80  
CRI > 90 C90

**BASO**  
basolighting.com  
xalusa.com

## Technical data

	SIZE TYPE	LED COLOR TEMPERATURE	INPUT WATTS	DELIVERED LM TOTAL	LIGHT DISTRIBUTION	DELIVERED LUMEN DIRECT	OPTICAL EFFICIENCY	LUMINAIRE EFFICACY
<b>PANO 5.25"</b>								
e LED	8' opal	40 K	35.4 W	4400lm	100% down	4400lm	81%	110lm/W
e <sup>2</sup> LED	8' opal	40 K	50.5 W	6200lm	100% down	6200lm	81%	106lm/W
e <sup>2+</sup> LED	8' opal	40 K	67.3 W	8000lm	100% down	8000lm	81%	98lm/W

for 27 K, 30 K or 35 K multiply lm value by 0.96

## WoodWorks® Grille Ceiling System Integration

(for more ceiling options, please see CEILING OPTIONS pages)

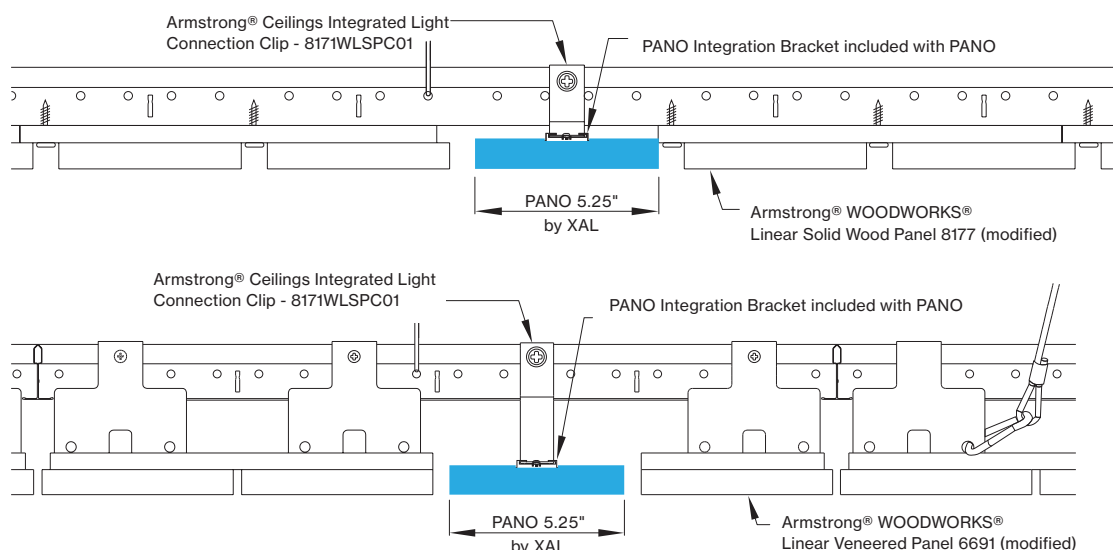

## Available lengths for ceiling types

CEILING TYPE	2 FT	4 FT	6 FT	8 FT
WoodWorks® Grille Tegular 9/16	23.375"	47.375"	n/a	n/a
WoodWorks® Grille Tegular 15/16	23"	47"	n/a	n/a
WoodWorks® Grille Classic	23"	47"	71"	95"
WoodWorks® Grille Forte	*23"	47"	71"	95"
WoodWorks® Linear Solid Wood panels	*23"	*47"	*71"	95"
WoodWorks® Linear Veneered panels	*23"	*47"	*71"	95.25"

\*Woodworks ceilings are not available in this length. Wood panels need to be cut in the field to fit this length.

## INTEGRATED LIGHT CONNECTION CLIP

Armstrong® Ceilings Integrated Light Connection Clip

visit  
[armstrongceilings.com/linearlighting](http://armstrongceilings.com/linearlighting)

please contact your Armstrong Ceilings rep

## WoodWorks® ceiling systems

XAL PANO is only approved for Armstrong® WoodWorks Grille Tegular 9/16, WoodWorks Grille Tegular 15/16, WoodWorks Grille, WoodWorks Linear Solid Wood panels and WoodWorks Linear Veneered panels ceiling systems. Refer to [armstrongceilings.com](http://armstrongceilings.com) for installation instructions related to the ceiling products.

DIMENSIONS

WLS - ARMSTRONG® WOODWORKS® LINEAR SOLID WOOD PANELS

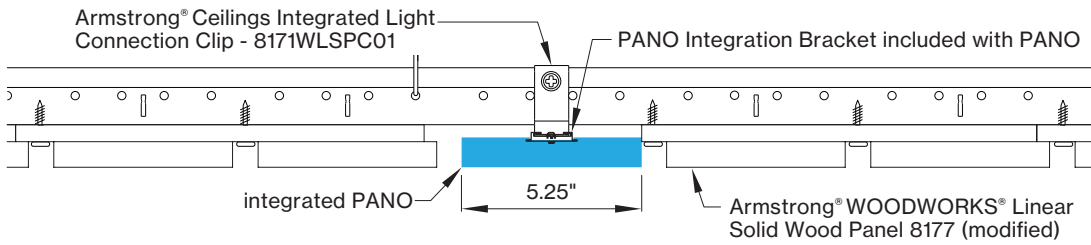

WLS view from below

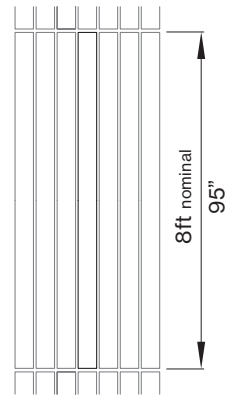

WLV - ARMSTRONG® WOODWORKS® LINEAR VENEERED PANELS

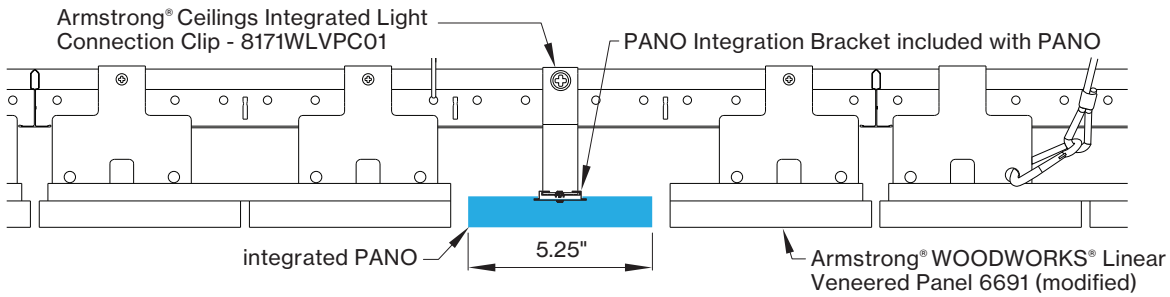

WLV view from below

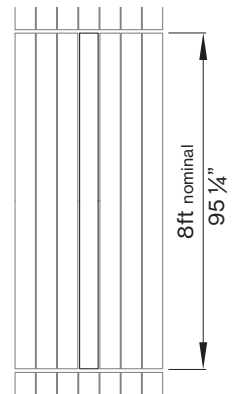

**PANO mounting instructions**

Get access to the PANO mounting instructions faster by scanning the QR code.

<https://www.xalusa.com/resources/cut-sheets/pano>

